

The Trolley™

Monitor lift System

Installation & Operating Instructions

Parts List



The Trolley™

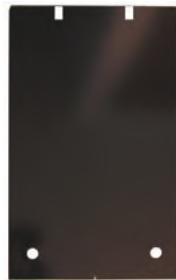

Removable Metal Front Cover



100mm VESA Plate



Qty. 4
Locking Plates



Qty. 1
Pan head #10 x 5/8
Black Screw for
front cover



Qty. 4
10-24 x 3/4
Locking Plate Screw,
Shorter



Qty. 1
4mm x 0.7
Anti-tilt screw, black
(Pre-installed in
Tounge of VESA Plate)



Qty. 4
8-32 x 7/8
Locking Plate Screw,
Longer

Tools (not included)



Phillips Screwdriver
Power screwdriver may also be used.

Note: Do not connect the Trolley™ to power source until step 4

Step 1:



1a. Remove Trolley™ and parts from shipping box.

1b. Place Trolley™ in it's upright, vertical position with the open interior side facing you.

Step 2:



2a. With arm in down position, remove black cable management cover.



2b. Remove right screw from cable retention clip on cable management channel. Then loosen left screw and rotate clip downward.

The Trolley™

Monitor lift System

Installation & Operating Instructions

Step 3:

Flat panel monitor (bottom view). Dell monitor pictured here. Other brands may vary.

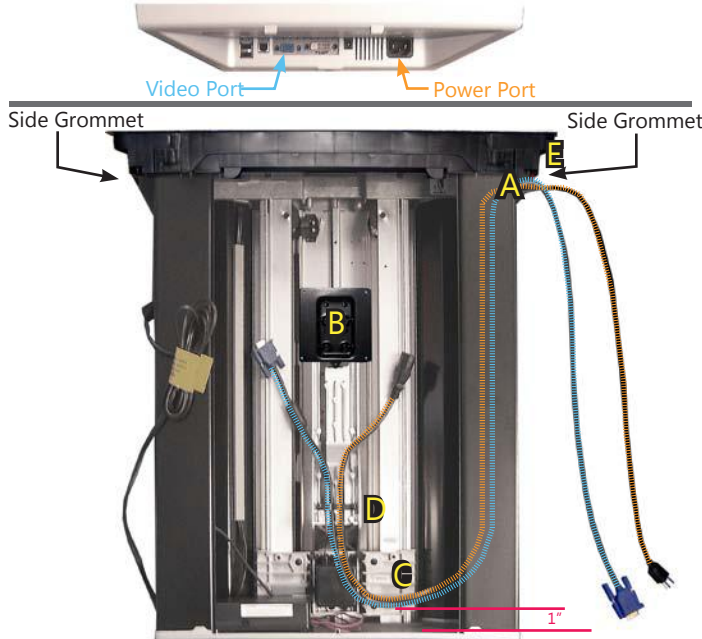

- A. Feed monitor video and power cables through the grommets on either side of the Trolley™.
- B. Align other end of video & power cables with ports on monitor. Position the end of the cables even with the center of the VESA plate on monitor arm. These cords may need adjustment in step 6b.
- C. Leave about 1" of clearance between the video/power cables and the bottom of the Trolley™.
- D. Place video/power cables in two center wire management channels on monitor arm. Bring wire clip (rotated downward in step 2b) back up over wires, aligning right side over screw hole. Tighten left screw, then reinstall and tighten right screw.
- E. Place video and power cables in wire retention clamps on side grommet. Secure screws in grommet. Make sure all wires are clear of screw hole. See figures 1 & 2.
- F. Reinstall black cable management cover that was removed in step 2.
- G. Completely remove two shipping screws indicated by the yellow warning label.



Fig. 1 - Side grommet with wire retention clamps

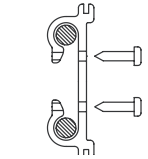
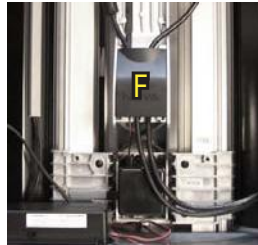
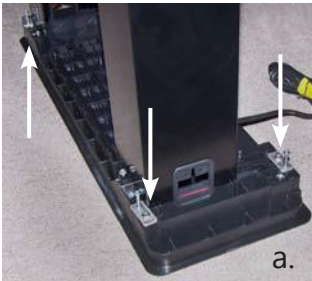

Fig. 2 - Top view of wire retention clamps



WARNING: After screws are removed and before monitor is installed, arm may move upward. If this happens, it should be stopped by holding it with your hand.

Step 4:



- 4a. Position locking plates as shown, over four threaded hole locations in Trolley™. Use (4) shorter 10-24 x 3/4 locking plate screws and tighten locking plates.

Insert (4) longer locking plate screws into second locking plate hole. Finish tightening in Step 4e.

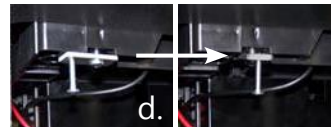

- 4d. Turn locking tabs 90°.



- 4b. With the open side of the Trolley™ facing the user side of the desk, place Trolley™ on work surface adjacent to work surface cutout.

Feed video and power cables through cutout.



- 4e. Tighten locking plate screws to work surface tight enough to prevent the Trolley™ from shifting.



- 4c. Lower Trolley™ into the cutout.

- 4f. Plug the Trolley™ into power source. Wait 5 seconds to activate, then push the UP button to open door and raise the Trolley™ arm.

The Trolley™ Monitor lift System

Installation & Operating Instructions

Step 5:

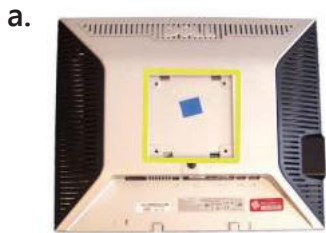

5a. Confirm appropriate size VESA plate for your monitor.
(100mm VESA plate installed)

Note: Once installed, the bottom of your monitor should be 1 1/2" to 2" above the closed Trolley™ door.

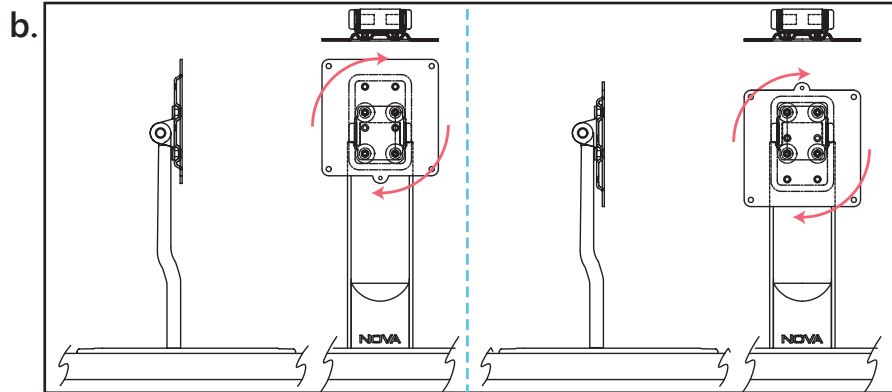

5b. VESA plates can be detached and rotated to ensure a monitor height clearance of 1 1/2" to 2" above the closed Trolley™ door.



Optional: If 75mm VESA plate is required, contact Customer Service at 1-800-730-6682

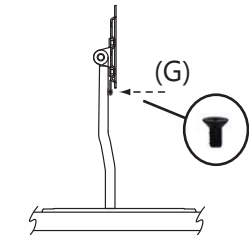

Note: To enable the adjustability of the monitor, remove the Anit-tilt Screw (G) which secures the VESA plate to arm.

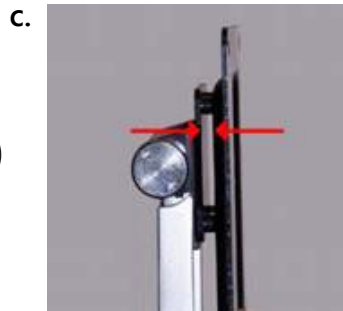

Using the flush screw holes increases the space between the monitor and the arm.

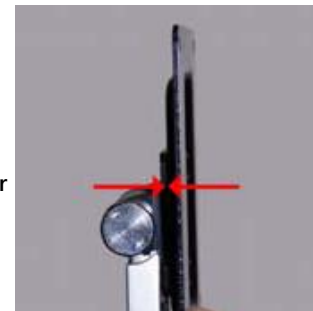

Using the indented screw holes decreases the space between the monitor and the arm.

5c. Depending on the depth of your monitor's VESA plate mounting area and/or the thickness of your monitor, different screw holes can be used to adjust the space between the monitor and the Trolley™ arm.

Step 6:

6a. Remove the four screws located on back of monitor.

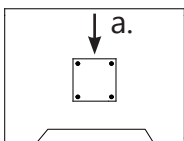

6b. Attach the video and power cables to your monitor. Allow enough slack in cables for easy tilting of monitor, but do not allow them to touch the work surface or interfere with Trolley operation

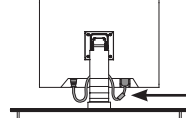

Note: cables should allow for monitor tilt, but should not touch work surface

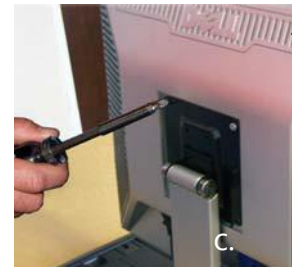

6c. Attach monitor to VESA plate using the four removed monitor screws.

Note: It may be helpful to have another person assist in holding the monitor while attaching it to the VESA plate.

Step 7:



7a. Push "Down" button for a few seconds to activate unit. Once the monitor is completely lowered into the Trolley™, the door will close automatically.

Note: Pushing the "Up" button will close the door.

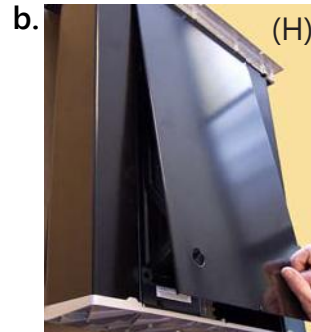

7b. Remove the black screw located at the bottom of the Trolley™ (H). Slide the top end of the removable metal front cover into the upper front cover slot.

Note: Top of front cover must slide inside the groove of the top structure.

Slide bottom of cover into Trolley™ aligning with screw hole. Reinstall the screw.



(H) Pan head #10 x 5/8 Black Screw for front cover

Overview

The Trolley™ EXL includes *Intelligent Motion Technology™*. This feature reduces the risk of accidental damage and personal injury. Utilizing information from various different sensors, *Intelligent Motion Technology™* continually monitors the Trolley's™ operational status and delivers information to the power control module.

If conditions create a "conflict" within the Trolley's™ programming, the system will automatically take action to reduce damage or injury. See below for some common operational conditions and how to resume normal operation.

Operational Guidelines / Troubleshooting

Condition	Operational Status	To Resume Operation...
<p><u>Power Failure</u></p> <ul style="list-style-type: none"> In the event of a power failure during operation... 	Unit will STOP	Once power is restored, push the "Up" button to resume normal operation. The Trolley™ will return to the "Up" position.
<p><u>Obstruction During Upward Motion</u></p> <ul style="list-style-type: none"> If someone or something obstructs the upward motion of the monitor (such as someone leaning on or pushing down on the monitor)... 	Unit will STOP	Once obstruction is cleared, push the "Up" button to resume normal operation. The Trolley™ will return to the "Up" position.
<p><u>Monitor is Tilted During Operation</u></p> <ul style="list-style-type: none"> If the monitor is moved out of vertical alignment while Trolley™ is operating... 	Unit will STOP	<p>Move monitor to fully vertical position. Push "Up" to resume normal operation.</p> <p>Note: The Trolley™ will not operate when the monitor is tilted</p>
<p><u>Access Door is Obstructed or Jammed</u></p> <ul style="list-style-type: none"> If the Trolley™ senses an obstruction in the path of the access door... 	Unit will STOP	The Trolley's™ "Over-current Sensor" will stop the unit from operating until the door obstruction is removed. Once the path is clear, push either "Up" or "Down" buttons to resume normal operation.

For more information on installation and operation of the Trolley™ EXL, please contact NOVA at 800-730-6682 or sales@novasolutionsinc.com