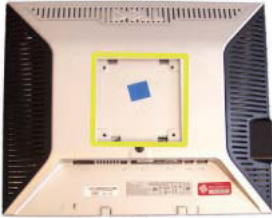

The Trolley™ Monitor lift System

Monitor Installation Instructions

Step 1:

a. 

1a. Confirm appropriate size VESA plate for your monitor. (100mm VESA plate installed)
Note: Once installed, the bottom of your monitor should be 1 1/2" to 2" above the closed Trolley™ door.

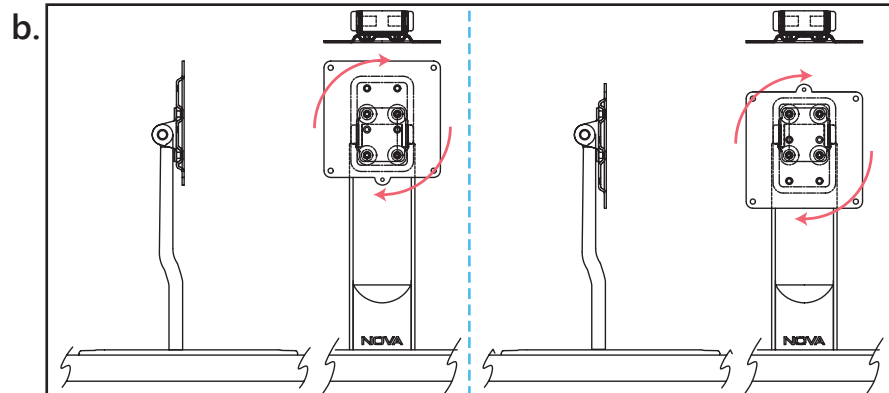

1b. VESA plates can be detached and rotated to ensure a monitor height clearance of 1 1/2" to 2" above the closed Trolley™ door.



Optional: If 75mm VESA plate is required, contact Customer Service at 1-800-730-6682

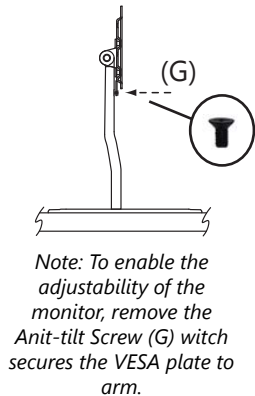

c. 

Using the flush screw holes *increases* the space between the monitor and the arm.



Using the indented screw holes *decreases* the space between the monitor and the arm.

1c. Depending on the depth of your monitor's VESA plate mounting area and/or the thickness of your monitor, different screw holes can be used to adjust the space between the monitor and the Trolley™ arm.

Step 2:

2a. Remove the four screws located on back of monitor.

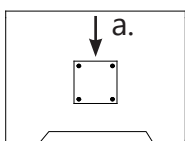

2b. Attach the video and power cables to your monitor. Allow enough slack in cables for easy tilting of monitor, but do not allow them to touch the work surface or interfere with Trolley operation

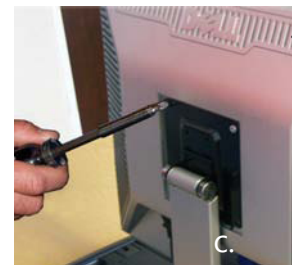
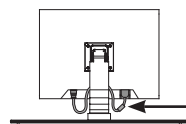

2c. Attach monitor to VESA plate using the four removed monitor screws.

Note: It may be helpful to have another person assist in holding the monitor while attaching it to the VESA plate.